

WALL NOT REQUIRED ON A SIDE

ELEVATION VIEW TYPE-1R

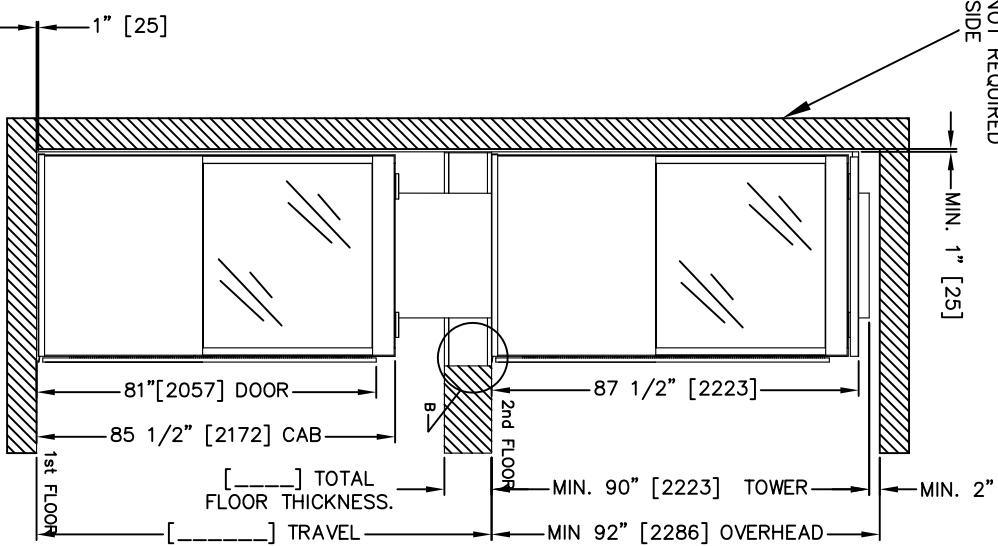

FLOOR PLUG SYSTEM

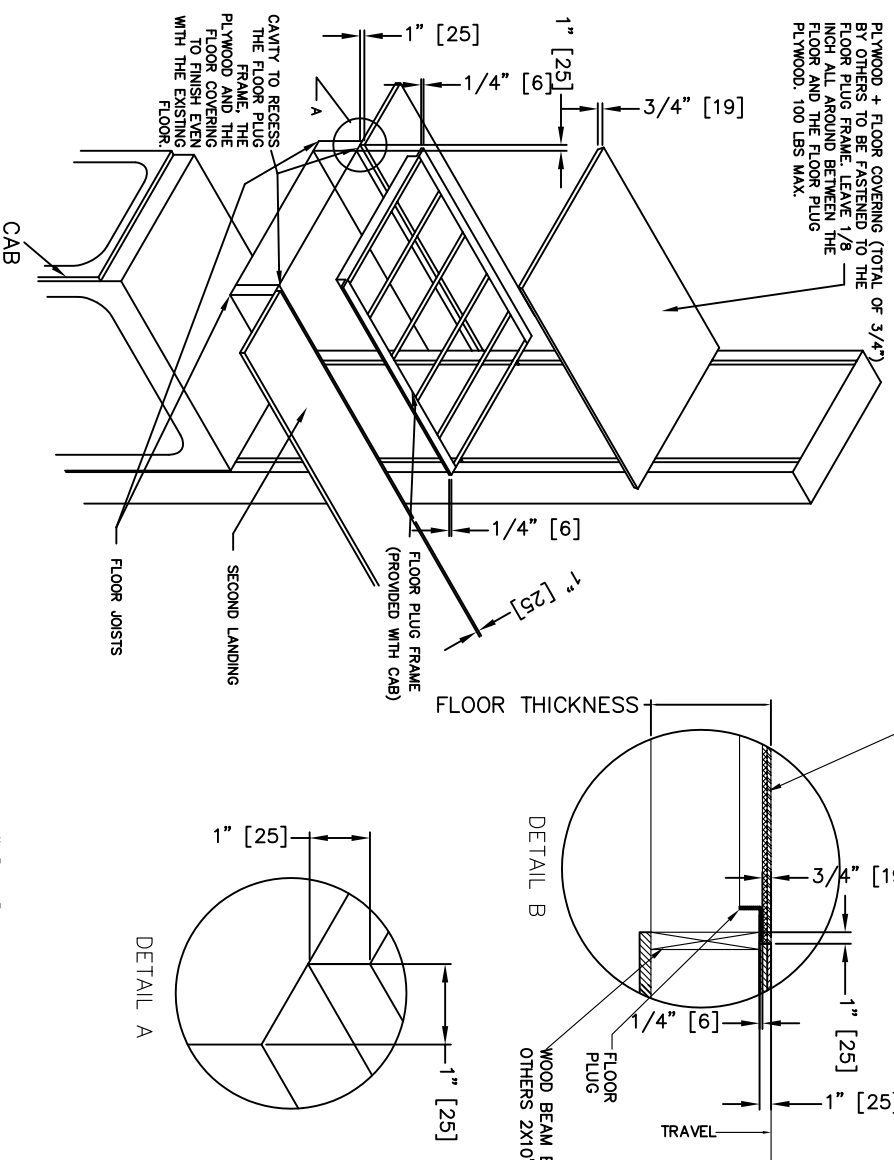

# TELECAB

## PROVISIONS BY OTHERS

**GENERAL**  
**HOSTWAY** - THE HOSTWAY MUST BE DESIGNED AND BUILT IN ACCORDANCE WITH "SAFETY STANDARD FOR PLATFORM LIFTS AND STAIRWAY CHARLIFTS" OR "SAFETY CODE FOR ELEVATORS AND ESCALATORS" AND ALL STATE/PROVINCIALS AND LOCAL CODES.  
**PLUMB RUNWAY** - DUE TO CLOSE RUNNING CLEARANCES OWNER/AGENT MUST ENSURE THAT HOSTWAY AND PIT (WHERE PROVIDED) ARE LEVEL, PLUMB (-/+ 1/8" (3 mm)) AND SQUARE AND ARE IN ACCORDANCE WITH THE DIMENSIONS ON THESE DRAWINGS.  
**MINIMUM OVERHEAD CLEARANCE** - OWNER/AGENT MUST ENSURE MINIMUM OVERHEAD CLEARANCE IS IN COMPLIANCE WITH CODES.  
**CONSTRUCTION SITE** - OWNER/AGENT TO PROVIDE ALL MASONRY, CARPENTRY AND DRYWALL WORK AS REQUIRED AND SHALL PATCH AND MAKE GOOD (INCLUDING FINISH PAINTING) ALL AREAS WHERE WALLS/FLOORS MAY REQUIRE TO BE CUT, DRILLED OR ALTERED IN ANY WAY TO PERMIT THE PROPER INSTALLATION OF THE LIFT.  
**DIMENSIONS** - CONTRACTOR/CUSTOMER TO VERIFY ALL DIMENSIONS AND REPORT ANY DISCREPANCIES TO OUR OFFICE IMMEDIATELY.  
**STRUCTURAL**  
**FLOOR/SUPPORT WALL LOADS** - STRUCTURAL ENGINEER TO ASSURE THAT BUILDING AND SHAFT WILL SAFELY SUPPORT ALL LOADS IMPOSED BY THE LIFT EQUIPMENT. REFER TO THE LOAD DIAGRAM ON THIS DRAWING.  
**MAST TO BE SECURELY FASTENED** - WHERE REQUIRED THE MAST MUST BE SECURELY FASTENED TO THE STRUCTURAL SUPPORT WALL. REFER TO WALL / FLOOR SUPPORT LOAD DIAGRAM AND WALL LAG DIMENSIONS ON THIS DRAWING.  
**ELECTRICAL**  
**GENERAL** - ELECTRICAL EQUIPMENT AND WIRING TO COMPLY WITH SECTION 38 OF CSA C22.1 (CANADA) OR SECTION 620 OF NEC ANS/NFPA 70 (USA).  
**POWER SUPPLY** - 120VAC, 20A, 60HZ, 1PH CIRCUIT THROUGH A FUSE DISCONNECT WITH AUXILIARY CONTACT ON MAIN POWER SUPPLY. PROVIDE TWO 18 AWG CONDUCTORS BETWEEN CONTACT AND CONTROLLER.  
**LIGHTING** - LIGHTING OF 100 LX MIN. AT PLATFORM AND LANDINGS. LIGHTING WITH SWITCH AND ELECTRICAL GFCI OUTLET IN HOSTWAY PIT.

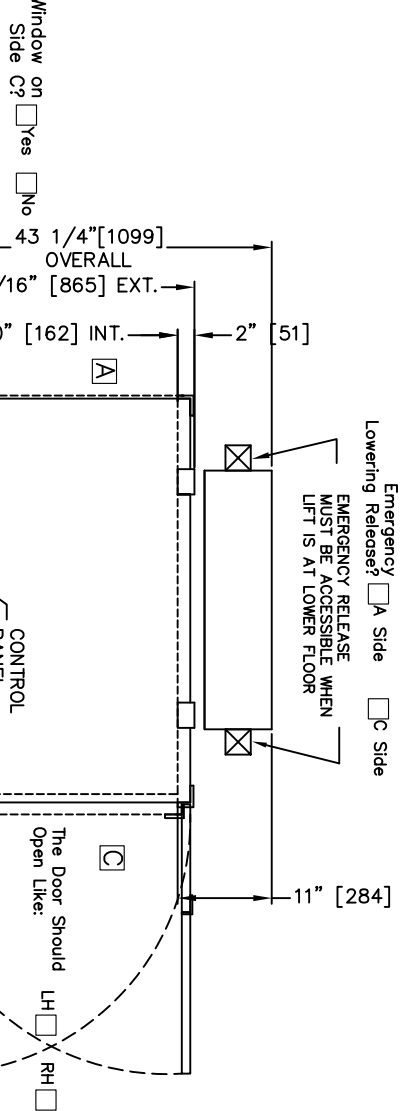

FLOOR CUT-OUT VIEW TYPE-1R

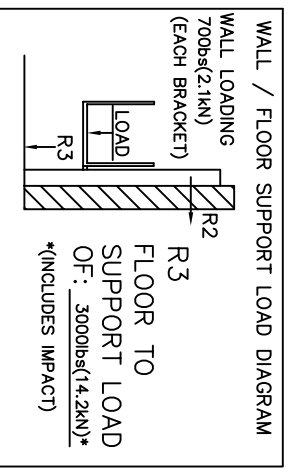
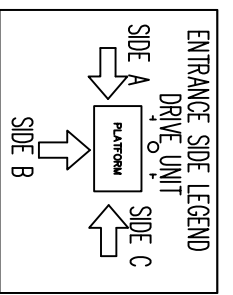
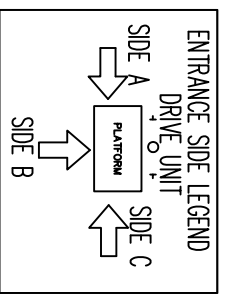
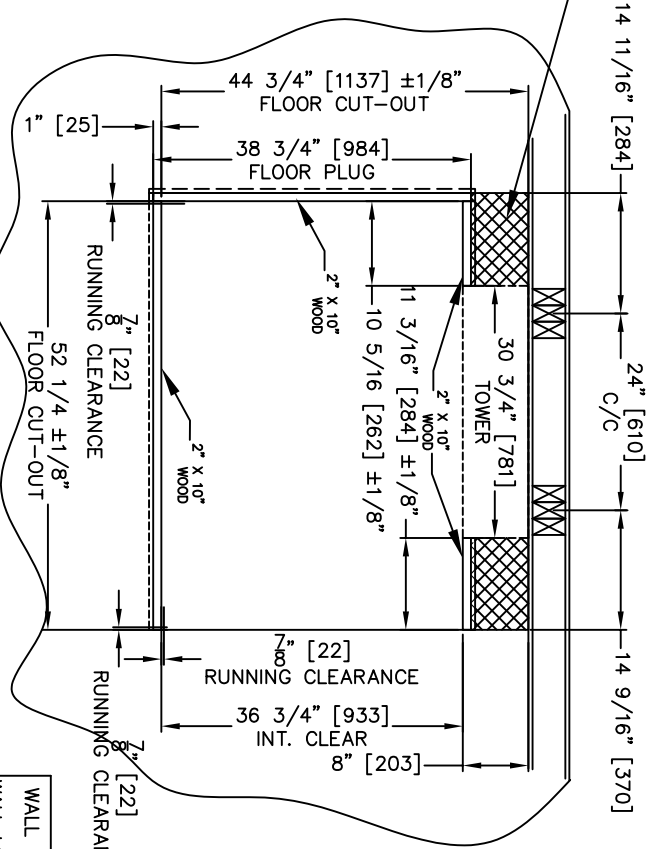

### FORCES

CLASSIFICATION	RESIDENTIAL BUILDING
TELECAB USABLE DIM.	30" x 47" x 78"
TELECAB CAPACITY	500 LBS [227 KG]
COLOR (URETHANE FINISH)	<input type="checkbox"/> WHITE <input type="checkbox"/> BEIGE
PLEXIGLASS TINT	<input type="checkbox"/> BRONZE <input type="checkbox"/> CLEAR
CAB DOOR OPERATION	<input type="checkbox"/> MANUAL <input type="checkbox"/> HYDRAULIC DOOR CLOSER
POWER	<input type="checkbox"/> POWER OPERATED
	<input type="checkbox"/> 110 VAC + 12 VDC DOWN STD
	<input type="checkbox"/> 12 VDC UP + DOWN
	<input type="checkbox"/> 220 VAC/50 HZ
HALL STATION	<input type="checkbox"/> SURFACE MOUNTED <input type="checkbox"/> FLUSH MOUNTED
BEARING WALL	<input type="checkbox"/> WOOD <input type="checkbox"/> CONCRETE
LEVEL SERVED	<input type="checkbox"/> 2 LEVELS
NUMBER OF OPENING(S)	<input type="checkbox"/> 1 OPENING
MAX. WORKING PRESSURE	2000 PSI
RELIEF PRESSURE	WP-x125% MAX
DRIVE SYSTEM	1 TO 2 CHAIN HYDRAULIC
CHAIN	#50, QTY: 2
CONTROLLER	RELAY LOGIC
OPERATION	CONSTANT PRESSURE, ANTI-CREEP FEATURE
FLOOR PLUG	PROVIDED

### SAFETY FEATURES

- 1) CSA CERTIFIED WR500 LOCK
- 2) UNDER PANEL SAFETY SENSOR
- 3) EMERGENCY STOP AND ALARM
- 4) EMERGENCY BATTERY LOWERING
- 5) EMERGENCY LOWERING
- 6) FULLY ENCLOSED DRIVE TOWER
- 7) PRESSURE RELIEF VALVE TO PREVENT PLATFORM OVERLOAD
- 8) SLACK CHAIN SAFETY DEVICE
- 9) TELEPHONE IN CAB
- 10) HALOGEN LIGHT IN CAB
- 11) NEGATIVE PRESSURE SWITCH

**CODE**  
 THIS LIFT IS DESIGNED, MANUFACTURED AND INSTALLED IN ACCORDANCE WITH THE FOLLOWING STANDARDS :  
 ASME A17.1 PART V 2007-08, CSA B44 2007-08, NEC AND IBC.  
 SAVARIA'S RESPONSABILITY IS LIMITED TO THE DESIGN AND MANUFACTURING REQUIREMENTS OF THESE CODES AND EXCLUDES REQUIREMENTS RELEVANT TO THE INSTALLATION AND INSTALLATION SITE.

CUSTOMER :	
PROJECT :	
DATE :	
PROJECTION	TOLERANCES IF NOT SPECIFIED
SCALE:	FRAC: ±1/8" [3]
DATE:	
DRAWING #	REV# PAGE: TITRE:

